

1-1' 断面詳細図

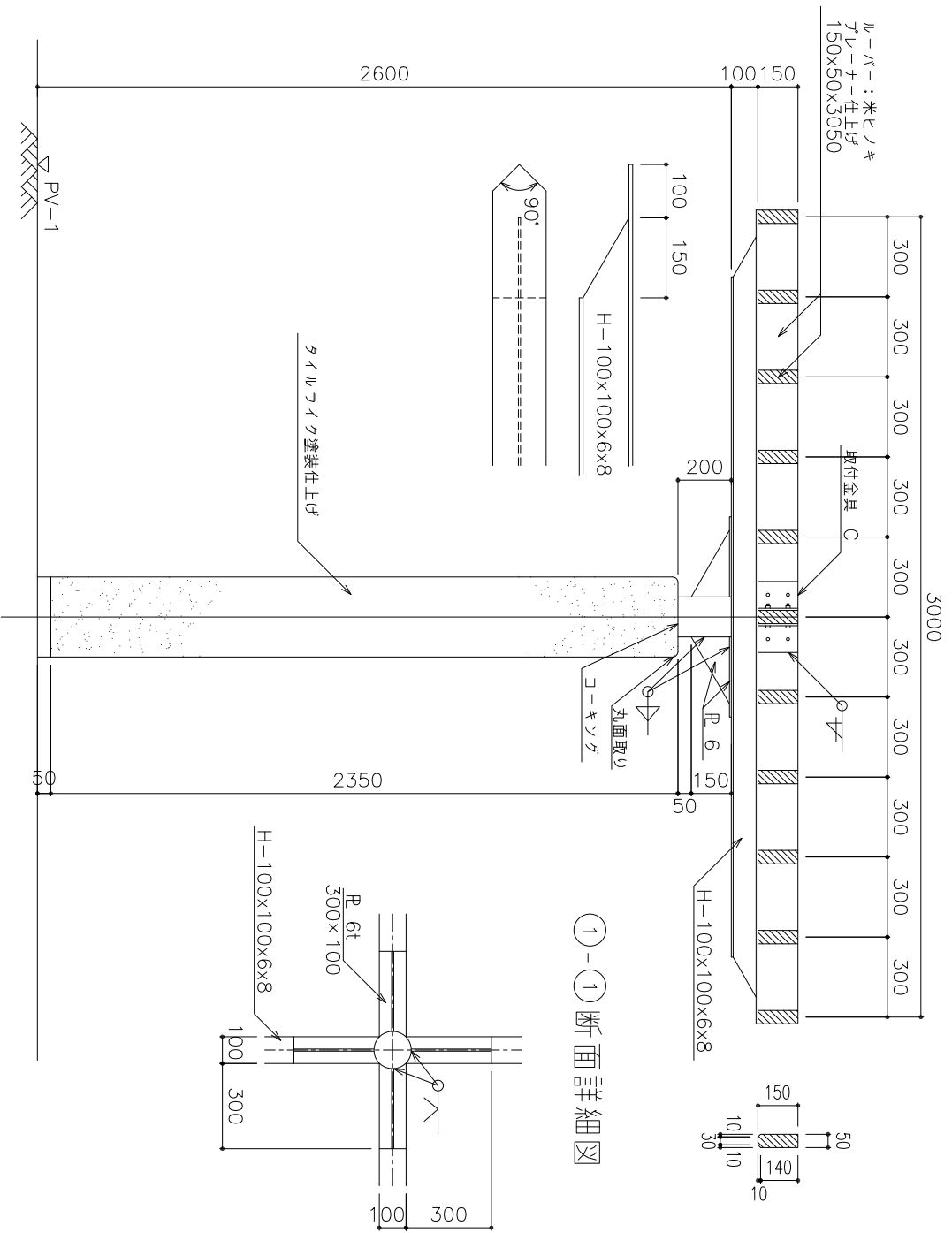

①-① 断面詳細図

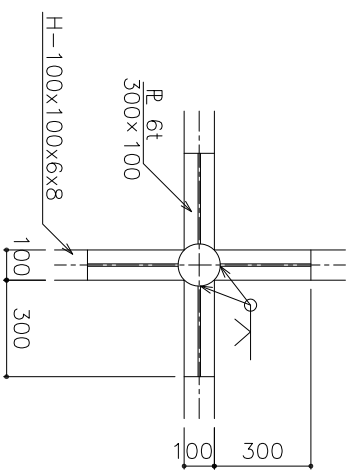

2-2' 断面詳細図

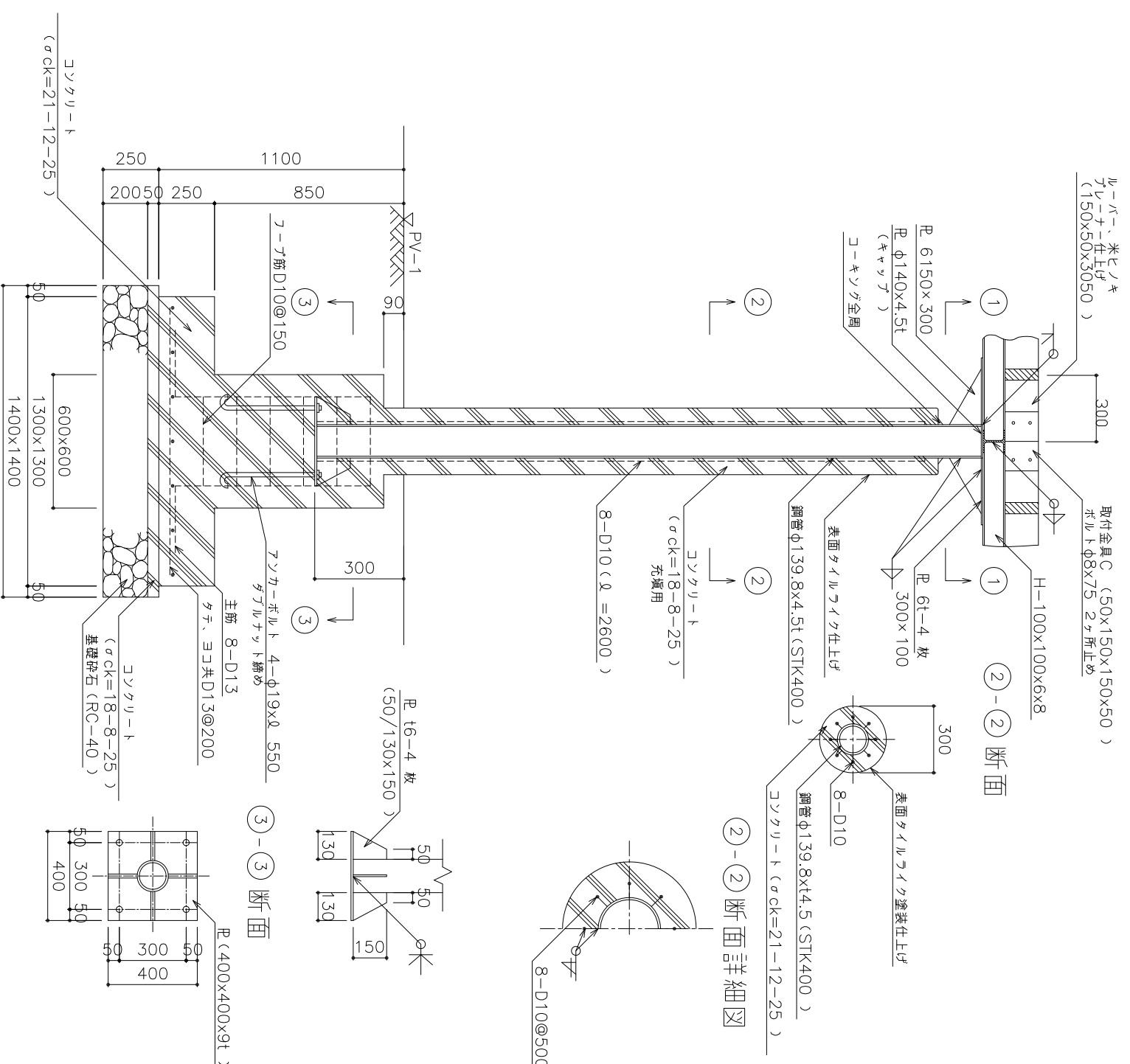

②-② 断面詳細図

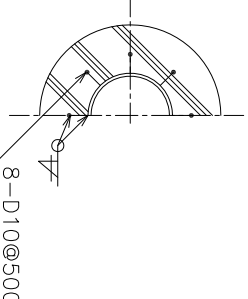

③-③ 断面

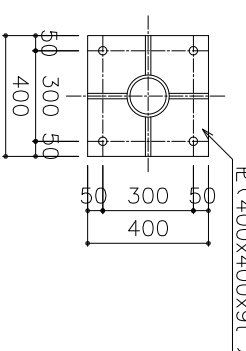

鉄筋加工図

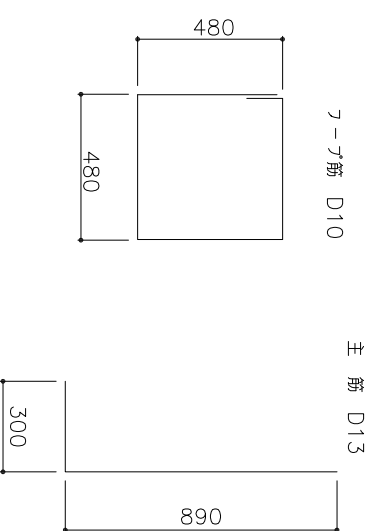

基礎伏図

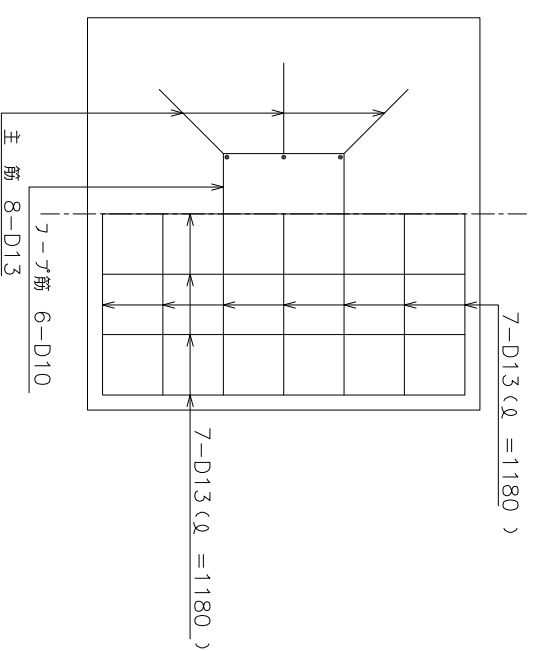

種別 パーゴラ工

図面名 パーゴラ (D) [参考図]

大阪市ゆとりとみどりの振興局